

# MIGNON 24 4000K 19°

Cod. 8804627464

## FLUSH-MOUNTING SPOTLIGHT

High-power 4-LED flush-mounting spotlight for indoor use, constant voltage supply, with grey-painted square frame.

### Technical data:

Power supply	24V DC
Current	0.36 A @24 V DC
Maximum power consumption	9W
Electrical insulation class	III
Connection	8cm OF SINGLE-POLE CABLE + TERMINAL
Beam angle	19°
Number of LEDs	4
LED colour	4000K
Colour Rendering	CRI>80
Total luminous flux	862 lumens
Body	ALUMINIUM
Finish colour	PAINTED GREY
Weight	0.1 kg
IP protection rating	IP20
Working position	FLUSH-MOUNTED
Cooling system	NATURAL CONVECTION
Ambient temperature limits	-20°C/+40°C

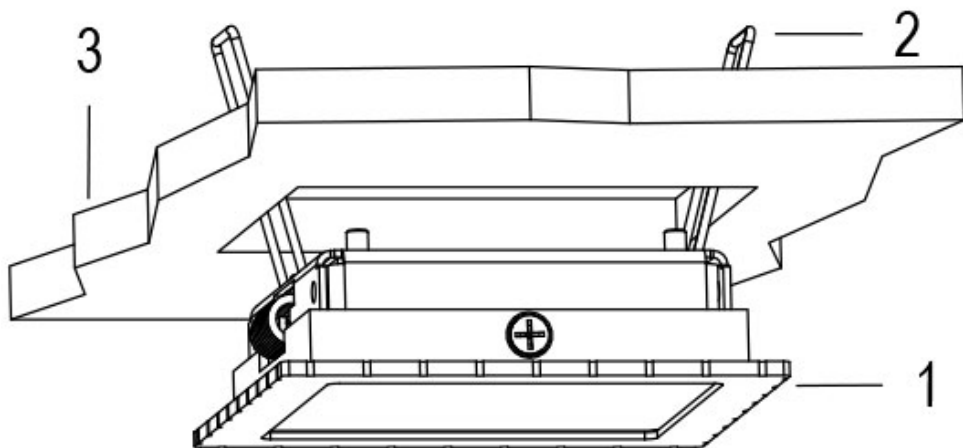
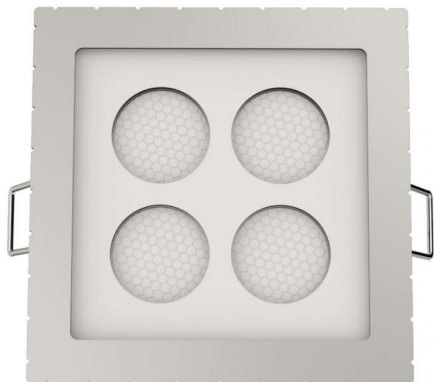

- 1 LAMP
- 2 FLUSH-MOUNTED SPRING
- 3 FALSE CEILING

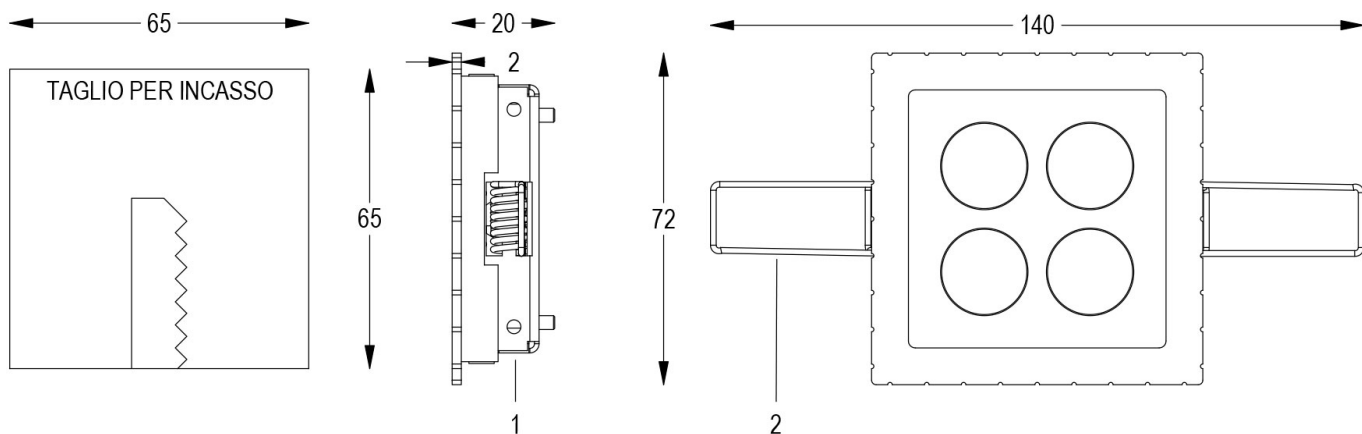

13/05/22 - The data in this document may be changed without notice in order to improve the product or to correct any errors.

# MIGNON 24 4000K 19°

Cod. 8804627464

## FLUSH-MOUNTING SPOTLIGHT

High-power 4-LED flush-mounting spotlight for indoor use, constant voltage supply, with grey-painted square frame.

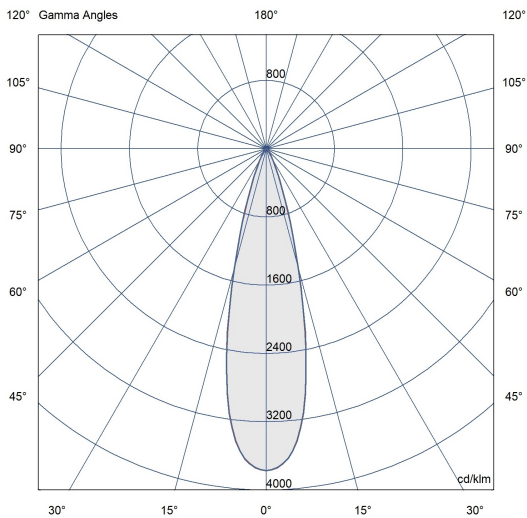

13/05/22 - The data in this document may be changed without notice in order to improve the product or to correct any errors.