

MIGNON 24 BL 3000K 80°

Cod. 8804755190

FLUSH-MOUNTING SPOTLIGHT

High-power 4-LED tilting flush-mounting spotlight for indoor use, constant voltage supply, with grey-painted square frame.

Technical data:

Power supply	24V DC
Current	0.36 A @24 V DC
Maximum power consumption	9W
Electrical insulation class	III
Connection	8cm OF SINGLE-POLE CABLE + TERMINAL
Beam angle	80°
Number of LEDs	4
LED colour	3000K
Colour Rendering	CRI>90
Total luminous flux	642 lumens
Body	ALUMINIUM
Finish colour	PAINTED GREY
Weight	0.15 kg
IP protection rating	IP20
Working position	FLUSH-MOUNTED (TILTING)
Cooling system	NATURAL CONVECTION
Ambient temperature limits	-20°C/+40°C

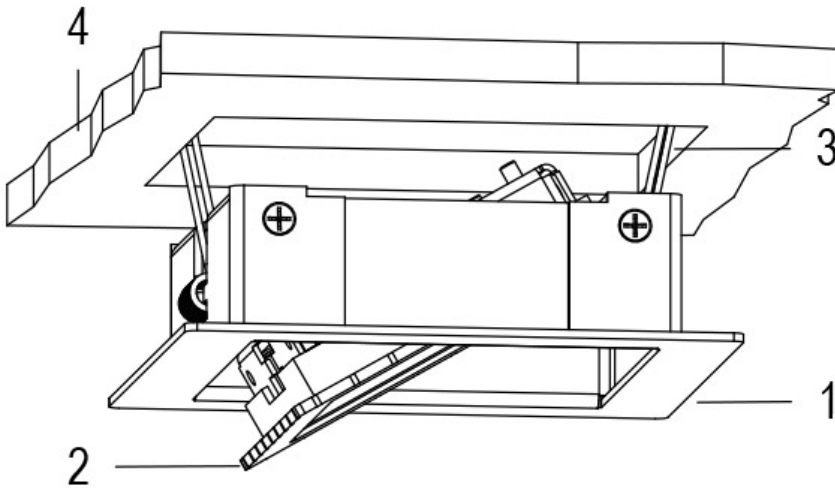
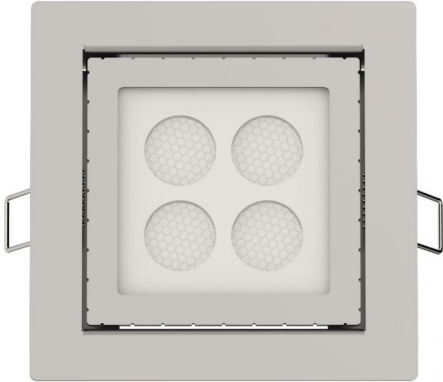

- 1 FIXING FRAME
- 2 TILTING LAMP
- 3 FLUSH-MOUNTED SPRING
- 4 FALSE CEILING

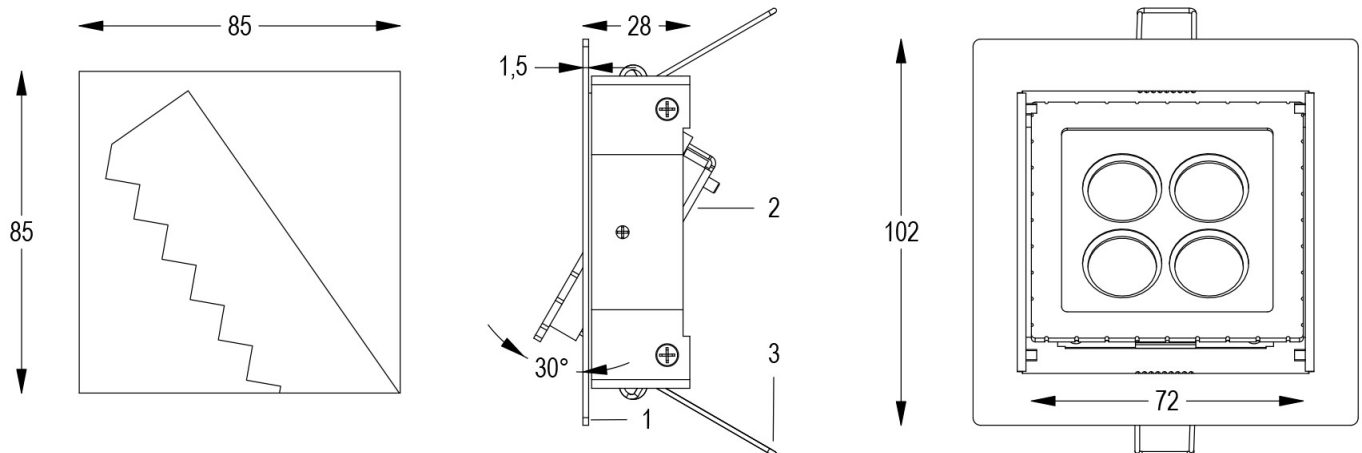

13/05/22 - The data in this document may be changed without notice in order to improve the product or to correct any errors.

MIGNON 24 BL 3000K 80°

Cod. 8804755190

FLUSH-MOUNTING SPOTLIGHT

High-power 4-LED tilting flush-mounting spotlight for indoor use, constant voltage supply, with grey-painted square frame.

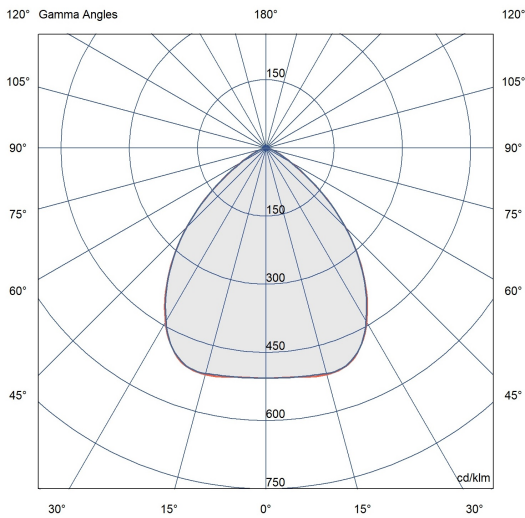

13/05/22 - The data in this document may be changed without notice in order to improve the product or to correct any errors.