

MICRO PUNTO WHITE 4000K 80°

Cod. 6801750064

SPOTLIGHT WITH FORMWORK and 1m of CABLE

Outdoor walkable fixed-color spotlight with 1 high-power LED. With round stainless steel flange polished to a mirror finish. Not suitable for permanent immersion. Guaranteed for 60 days of full immersion. Complete with power cord and formwork. DIMMABLE WITH SPECIAL ACCESSORY. OTHER COLOR TEMPERATURES ON REQUEST.

Technical data:

Power supply	24V DC
Current	0.15 A
Maximum power consumption	3,5 W
Electrical insulation class	III
Connection	1 m OF NEOPRENE CABLE 2X0,75
Maximum cable length	250 m
Beam angle	80°
Number of LEDs	1
LED colour	4000K
Colour Rendering	CRI>80
Total luminous flux	218 lumen
Body	ANODIZED ANTICORODAL ALUMINIUM + AISI316L STAINLESS STEEL
Finish colour	POLISHED STEEL
Weight	0,2 Kg
IP protection rating	IP68
Working position	WALKABLE
Cooling system	NATURAL CONVECTION
Ambient temperature limits	-20°C/+40°C

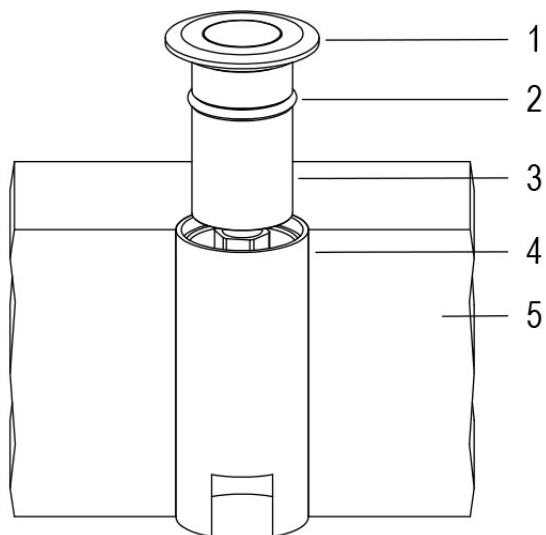
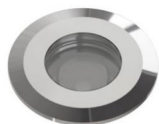

- 1 AISI316L STEEL RING NUT
- 2 RUBBER RING
- 3 ANODIZED ALUMINIUM
- 4 PLASTIC FORMWORK
- 5 FLOORING

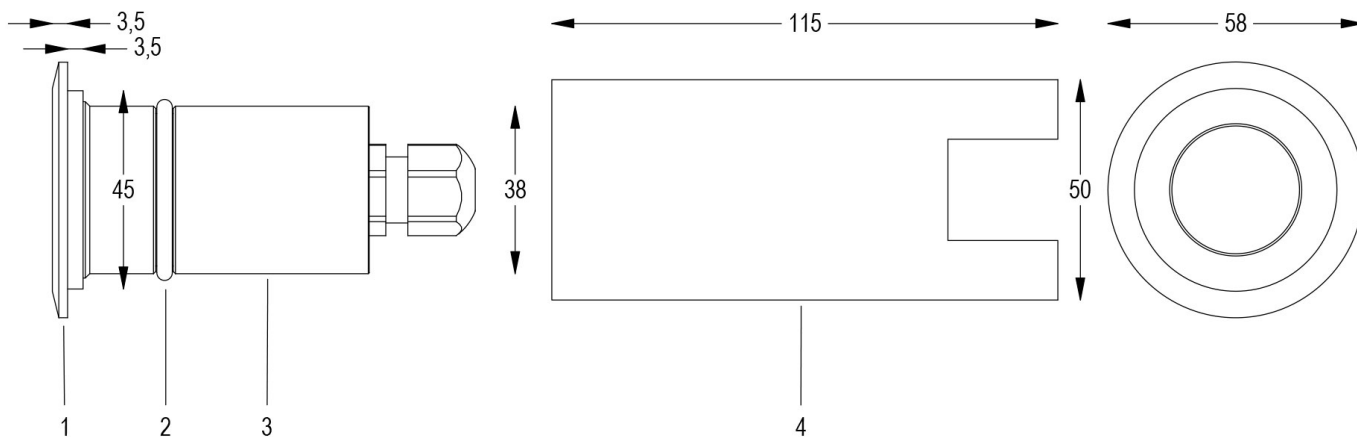

16/05/22 - The data in this document may be changed without notice in order to improve the product or to correct any errors.

MICRO PUNTO WHITE 4000K 80°

Cod. 6801750064

SPOTLIGHT WITH FORMWORK and 1m of CABLE

Outdoor walkable fixed-color spotlight with 1 high-power LED. With round stainless steel flange polished to a mirror finish. Not suitable for permanent immersion. Guaranteed for 60 days of full immersion. Complete with power cord and formwork. DIMMABLE WITH SPECIAL ACCESSORY. OTHER COLOR TEMPERATURES ON REQUEST.

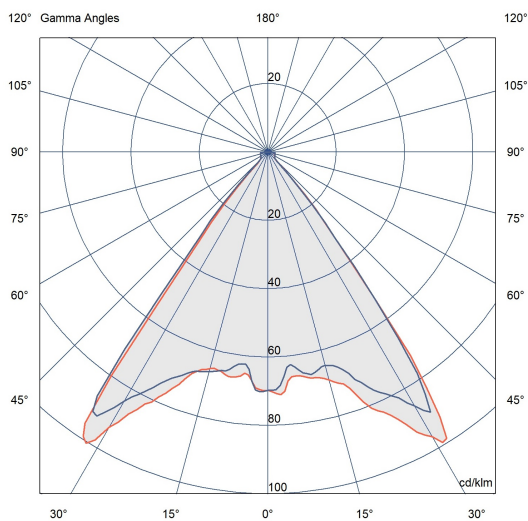

16/05/22 - The data in this document may be changed without notice in order to improve the product or to correct any errors.